

# ONDURA<sup>®</sup> EDGE

INSTALLATION  
INSTRUCTIONS

---



  
**Made**  
*by me!*



**Onduline<sup>®</sup>**  
Lightweight roofing systems

# ONDURA® EDGE



## TECHNICAL CHARACTERISTICS

LENGTH	79 inches
WIDTH	35 inches
THICKNESS	1/8 inch
CORRUGATION HEIGHT	1.5 inches
CORRUGATION PITCH	3.8 inches
PRODUCT SURFACE	19.2 ft <sup>2</sup>
WEIGHT OF PANEL	11.9 lbs.
WEIGHT OF GROSS SURFACE	0.62 lbs./ft <sup>2</sup>
CORRUGATIONS	5 + 4 flats
OVERLAP	4 inches
NET COVERAGE AREA	16.1 ft <sup>2</sup> ≈ 6.2 panels/100ft <sup>2</sup>



## COLOR OPTION



Red



Black



Green



Brown

## FAST AND EASY INSTALLATION FOR ALL TYPES OF PROJETS



No special tools required



Lightweight for easy transportation



No sharp edges



Install over purlins, solid decking, or shingles to save time



Embossment lines to help reduce material waste and cost



Wind resistant\*\*

ONDURA® products are intended for use in outbuilding constructions.

\* See terms and conditions on [tuftex-ondura.com](http://tuftex-ondura.com)

## THANK YOU for choosing ONDURA® EDGE for your roofing project.

ONDURA® should be carefully installed. Mistakes during the installation process can cause problems later and impact the warranty. Please take the time to closely follow these installation guidelines.

**CAUTION** Installation of roofing materials can be dangerous. Danger typically increases as the steepness of the roof pitch and the height from the ground increases. Do not install in inclement weather conditions. Assess your specific installation situation as various other factors can also contribute to installation hazards. We strongly recommend that anyone installing ONDURA® or working on a roof in any manner take all possible precautions to ensure their personal safety at all times. Be sure ladders and other such devices are safely positioned and properly secured. OSHA recommends the use of a safety harness when applying roofing. Protective eye-wear is recommended when using power tools and throughout the ONDURA® installation. ONDURA® may be slippery when wet, dusty, frosty, or oily. Please avoid working or walking on the roof if any of these conditions exist. We recommend you do not attempt to install ONDURA® during storms, high winds, or other dangerous conditions.

### PROJECT PLANNING & REQUIREMENTS

#### ▶ THIS GUIDE PROVIDES INSTRUCTIONS FOR 2:12 SLOPE OR GREATER

*Minimum Slope Possible = 1:12 with additional waterproofing*

Always review and comply with local building regulations and safety guidelines.

ONDURA® can be installed over most existing annex building roof, always on solid deck (plywood/OSB type), with slopes of 2:12 or greater.

End lap = 4 inches (overlap embossed lines), side lap = 1 corrugation.

In areas with little to no snow, ONDURA® EDGE can be installed with slopes of 1:12, but always on solid deck, with superior overlaps: End lap 8 inches (2 corrugations), side lap 2 corrugations + 1 flat section.

#### ▶ STORAGE

ONDURA® panels must be covered to protect from damage from stagnant rainwater between the panels. **Do not** allow stacked panels to get wet while stored.

#### ▶ CUTTING PANELS

ONDURA® panels may be cut with a utility knife with a hook blade when parallel to the corrugation. Use a hand or circular saw with a plywood blade or fine-tooth blade reversed with the colored side down when cutting across the corrugation. For best results, mark with chalk line or soapstone marking tool and use lubricating oil on your blade when cutting.

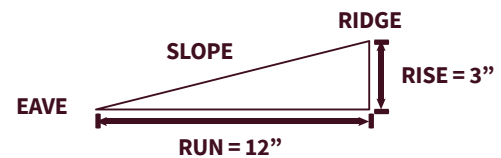

#### ▶ TOOLS REQUIRED



#### CAUTION

**DO NOT** stand directly on the corrugations  
**DO NOT** steam or pressure clean ONDURA® panels  
**DO NOT** stand on the flat sections when installed on purlins

### COMPONENTS & ESTIMATING GUIDE

#### ▶ ACCESSORY ESTIMATION

##### NUMBER OF RIDGES FOR PROJECT

Total Ridge Length (inches) + 4 inches  
32.5 inches

## INSTALLATION STAGE

If possible, we recommend placing the first row of ONDURA® panels on the roof to confirm coverage overlaps before installation of the panels. ONDURA® panels should always be used with the colored side out facing the elements. This is the side where the embossment lines at the top and bottom of the panel protrude out toward you.

### ► PLACEMENT OF ONDURA® PANELS

If more than one row of ONDURA® panels is needed, then the panels must be installed along the eave first. Then additional rows are installed above the previous row.

Stagger the position of the corrugation overlap for each row by starting the second row with a panel that has fewer corrugations. As a general guide, using an ONDURA® panel cut in half (parallel to corrugation) is typically a good way to begin the second row. Then repeat the pattern until reaching the ridge.

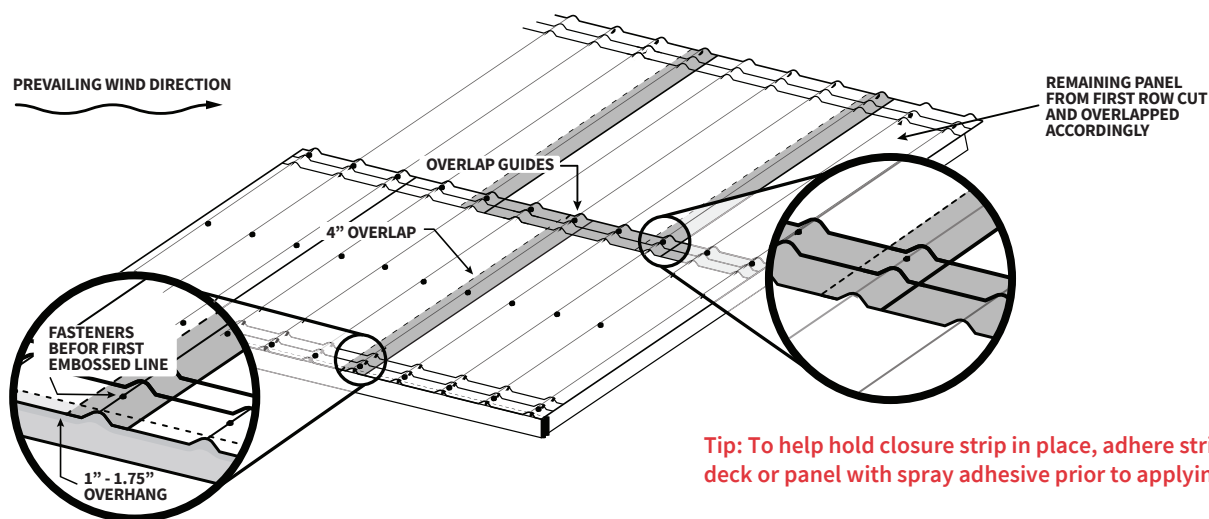

Each row should be installed with the first panel at the opposite end of the roof from the prevailing winds. With this orientation, the seam of the overlap will face away from the prevailing winds. If wind-driven rain could come from both directions, then we recommend sealing along the overlap with an elastomeric caulk.

### ► PANEL ALIGNMENT

Place first ONDURA® panel on roof. Align the ONDURA® panel to the rake edge. Align the eave edge of the ONDURA® panel to overhang the eave by 1 to 2.5 inches.

### ► CLOSURE STRIP POSITION

Place closure strips under the ONDURA® panel with the curved side up to fill the corrugations. The closure strips must be placed where the fasteners will be located so that the fasteners will securely hold the closure strips in place.

**Tip:** To help hold closure strip in place, adhere strip to the deck or panel with spray adhesive prior to applying fixation.

### ► FASTENER POSITIONING

Genuine ONDULINE® Fasteners are recommended for use on all ONDURA® products. ONDULINE® Fasteners are specially designed to seal around the fixation point and are color matched.

For your concluding row and when overlapping panels, place a fastener in every corrugation.

For overlapping sections (indicated in grey on the illustrations below) place a fastener in each overlapping corrugation at every point as shown in the diagrams below.

Make sure the panels and/or ridge caps are properly aligned before fastening in the overlapping sections.

See example diagrams below. Grey indicates overlap.

#### ► Fastener pattern

1. Place fastener in every corrugation of starting row, except for any areas where ridges or other panels will overlap.
2. Repeat for the second and third row of fasteners as indicated below.
3. Conclude with the ends and top row (grey area) only when overlapping panels or ridge cap is in place. Place fasteners on every corrugation.

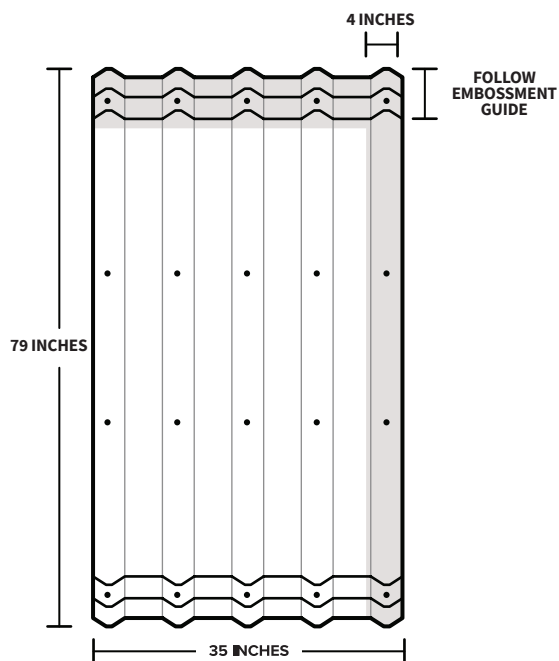

## INSTALLATION STAGE (CONTINUE)

### ▶ FASTENER INSTALLATION

Drive ONDULINE® screws only through the crown of the corrugation and always perpendicular to the roof's surface. Be careful not to overdrive the screw. The rubber washer on the screw should snugly contact the panel without dimpling the panel. When appropriately installed, slight hand pressure on an affixed corrugation should not separate the panel from contacting the washer.

Install screws on the first panel along the eave and rake edges. Install screws at remaining positions that are not going to be overlapped by other panels.

### Place next piece of ONDURA® on to the roof:

- ▶ The panels must overlap by at least one corrugation along the direction of the eave.
- ▶ The panels should overlap by aligning the embossment guide following the direction of the rake edge.

Install screws on the next panel in the same manner as the first panel. For the last panel in a row, install in the same pattern as previous panels and in the final corrugation along the rake edge.

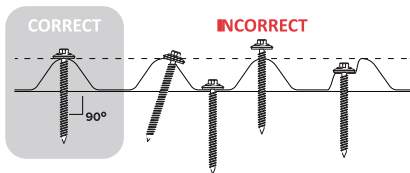

### ▶ RAKE TRIM

Finishing your rake edge with an ONDURA ridge to improve waterproofing and wind resistance. Using ONDULINE fasteners, affix it to the sidewall and then to the top of the second corrugation. This should be repeated for all rows of fasteners.

### ONDURA® Ridge Cap Edge

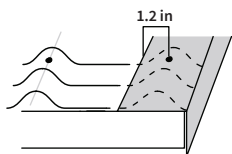

BE SURE TO TRIM RIDGE CAP TO ALLOW FOR NO MORE THAN 2 INCHES OF OVERLAP OCCURS BETWEEN THE FIRST CORRUGATION AND FLAT.

Alternatively, you could use a one corrugation strip from an ONDURA® panel under the last corrugation edge, or secure the last corrugation directly to a raised rake edge.



Metal flashing may also be used either over or under the last corrugation edge.

### Metal Flashing Over

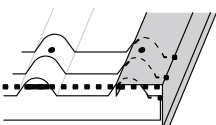

### Metal Flashing Under

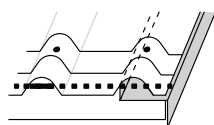

### ▶ RIDGE CAP

*Note: Install all panels on both sides of the roof before installing the ridge cap.*

Measure the ridge to determine the required coverage. Ridge caps are 39.5 inches long. If more than one ridge cap is needed, they must be installed with a 7 inch overlap. The overlap must be over a corrugation so that the overlap is fastened with a screw through the corrugation. For resistance to wind uplift, the exposed end of the ridge cap must be no more than 1.75 inches from the closest screw position on a corrugation.

Place the first ridge cap at the ridge end, away from the prevailing wind. Allow for at least a 1-inch overhang over the ridge end.

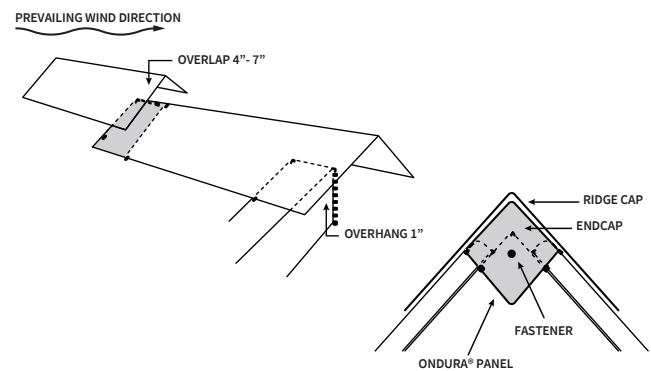

Insert ridge closure strip on the ONDURA® panel and under the ridge cap after all ONDURA® panels have been placed.

The closure strip must be placed where the fasteners will be located to secure the closure strip. The center of the closure strip should be 1-inch above the lowest end of the ridge cap.

Install fasteners through the ridge cap and closure through every crown (top of corrugation) of the underlying panel. The fasteners should be 1 inch above the lower edge of the ridge cap. Do not install the ending fasteners until your ridge is capped with an endcap.

Allow for 1/2 to 2 inches of overhang at each end of the structure, beyond the edge of the roof panels or any drip edges.

Where necessary, cut the overhang portion of the ridge cap along the crown with a utility knife.

Create an endcap to prevent water intrusion by using excess ONDURA® ridge cap or other materials (such as wood or exterior metal) to cover the peak area under the ridge as shown. Cut the endcap to any shape you find aesthetically pleasing provided it follows these guidelines:

- ▶ Ensure the top point fits snugly into the underside of the ridge cap
- ▶ The ridge cap should come over the top of the end cap
- ▶ The corners on the left and right sides should cover the ONDURA® panels, with the left and right points slightly below the lowest point where the panels terminate.

If you used ONDURA® material to create your end cap, affix your end cap with 1 to 3 ONDULINE® color match fasteners, positioning may vary based on your endcap size and on your roof structure. If there is excess ridge cap overhang beyond your endcap you may trim it down, provided the ridge cap covers the top of the end cap in its entirety.

## ADVANCED INSTRUCTIONS

### ▶ VALLEY FLASHING

For valleys, install a minimum 18-inch wide metal valley flashing. Cut sheets at an angle to fit the valley; then turn over, and on the undersides along the valley edge, caulk two corrugations of the ONDURA® closure strip, and place into the corrugation. Then put a ½-inch bead of caulking on the flat side of the closure strips and along the corrugation of the sheet between the closure strips. Turn sheets right side up, carefully lay in place so caulked closures seat on flashing, and fastener in place at least 12 inches up from the center of valley without puncturing the metal flashing.

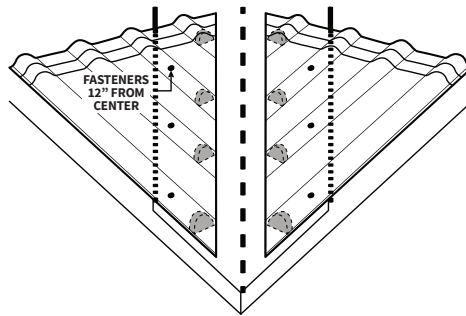

### ▶ WALL FLASHING

See the examples below for when ONDURA® panels meet a wall.

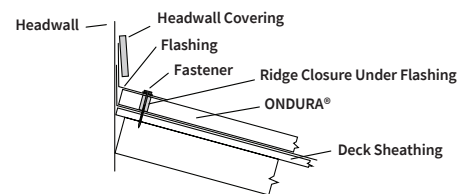
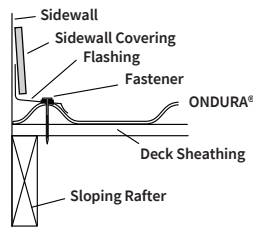
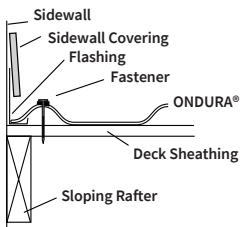

### ▶ SLOPE CHANGES

Flashing width should increase as slope differences increase or whenever water buildup on the lower slope can be substantial.

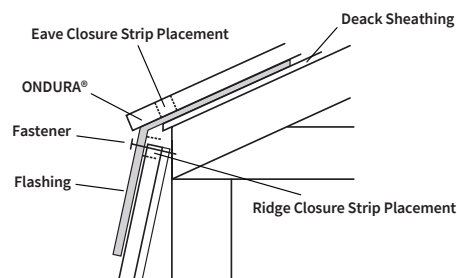
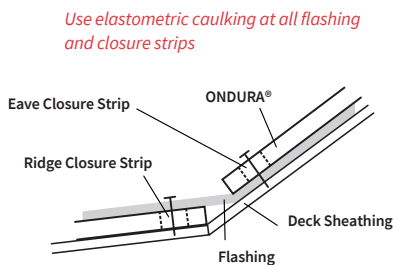

## ▶ HANDLING HIP

For hips, sheets from either side must meet to support hip cover. To cover the hip, use an ONDURA® Ridge Cap. Framing should be in place beneath and near enough to the upper ends of the screws securing the hip cover.

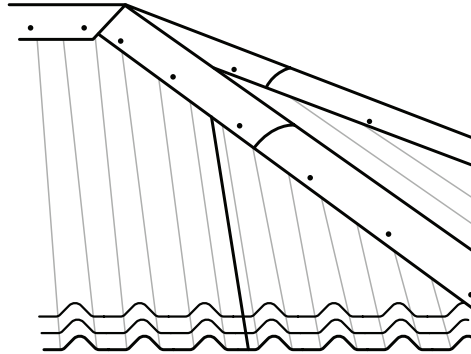

Snap chalk lines on each side of the hip to mark the area of the hip cover. See diagrams.

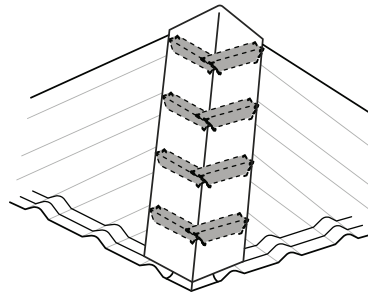

### > Closure Strips

Cut one hip section or two corrugations from the ONDURA® closure strip. Attach to the top side of the ONDURA® sheet with rubberized elastomeric flashing cement/caulk. Install with 7-inch end laps.

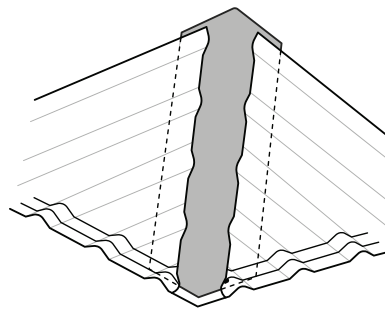

### > Butyl Tape Method

Seal top with single-sided butyl flashing tape. Then install the hip cover with 7-inch end laps over the flashing.

Exclusive distributor for  
the USA & Canada



tuftex-ondura.com



Onduline reserves the right to amend product specifications without prior notice. Products shown in this document should not be taken as being available ex-stock and reference should be made to the current Onduline price-list or advice sought from Onduline Customer Service Department. The information, technical details and fixing instructions etc. included in this literature are given in good faith and apply to uses described. Recommendations for use should be verified for suitability and compliance with actual requirements, specifications and any applicable laws and regulations. For other applications or conditions of use, Onduline offers a Technical Advisory Service, the advice of which should be sought for uses of Onduline products that are not specifically described herein. To ensure you are viewing the most recent and accurate product information, please scan the QR code directly above.



**ONDULINE**

5-7 Rue Frédéric Clavel  
92150 Suresnes  
FRANCE

**onduline.com**



**Onduline®**  
Lightweight roofing systems